



2007

PARTS MANUAL

THIS JIM COLEMAN COMPANY WORLD CLASS CARWASH
EQUIPMENT PARTS MANUAL INCLUDES PICTURES
AND PART NUMBERS FOR THE FOLLOWING EQUIPMENT:

FusionX
COMBINATION WASH

PARTS DEPARTMENT
1.866.927.4229
713.590.6652 FAX

WWW.JCOLEMANCO.COM



Please Read

The equipment shown on the following pages are from a typical Fusion X product. The purpose of this manual is to simplify the process and increase the accuracy when ordering parts. Please note that with the variety of options available, your equipment may have additional components or not have some of the components shown.

In the interest of product improvement, Jim Coleman Company reserves the right to make equipment modifications at any time and without advance notice

For more information on world class car wash equipment and parts manufactured by Jim Coleman Company please contact us at:

1.800.999.9878
5842 W. 34th Street
Houston, Texas 77092
www.jcolemanco.com

Parts Department Direct Line:
1.866.927.4229
Fax: 713.590.6652

2007 FUSION X PARTS MANUAL

TABLE OF CONTENTS

Page

GANTRY

05

Gantry – Side Brush Carriage – Right Side	10
Gantry – Side Brush Carriage – Left Side	12
Gantry – Driver’s Side	14
Gantry – Driver’s Side – Front View	16
Gantry – Upper – Driver’s Side	18
Gantry – Passenger’s Side – Exit End View	20
Gantry – Passenger’s Side – Front View	22
Gantry – Upper – Passenger’s Side	24
Gantry – Wheel Brush Assembly	26
Gantry – Wheel Brush Assembly	28
Gantry – Electrical Panel	30
Gantry – Electrical Panel – Upper	32
Gantry – Electrical Panel – Lower	34
Gantry – Sparklesoft	36

PUMPSTAND

40

Pumpstand – Low Pressure Pumps	44
Pumpstand – Back	46
Pumpstand – Pump End	48
Pumpstand – Motor End	50
Pumpstand – Control Panel	52
Pumpstand – Electrical Control Center	54
Pumpstand – ECC – Upper	56
Pumpstand – ECC – I/O Cards	58
Pumpstand – ECC – CPU	60

gantry





GANTRY ENTRANCE - WITH SKINS



GANTRY EXIT - WITH SKINS

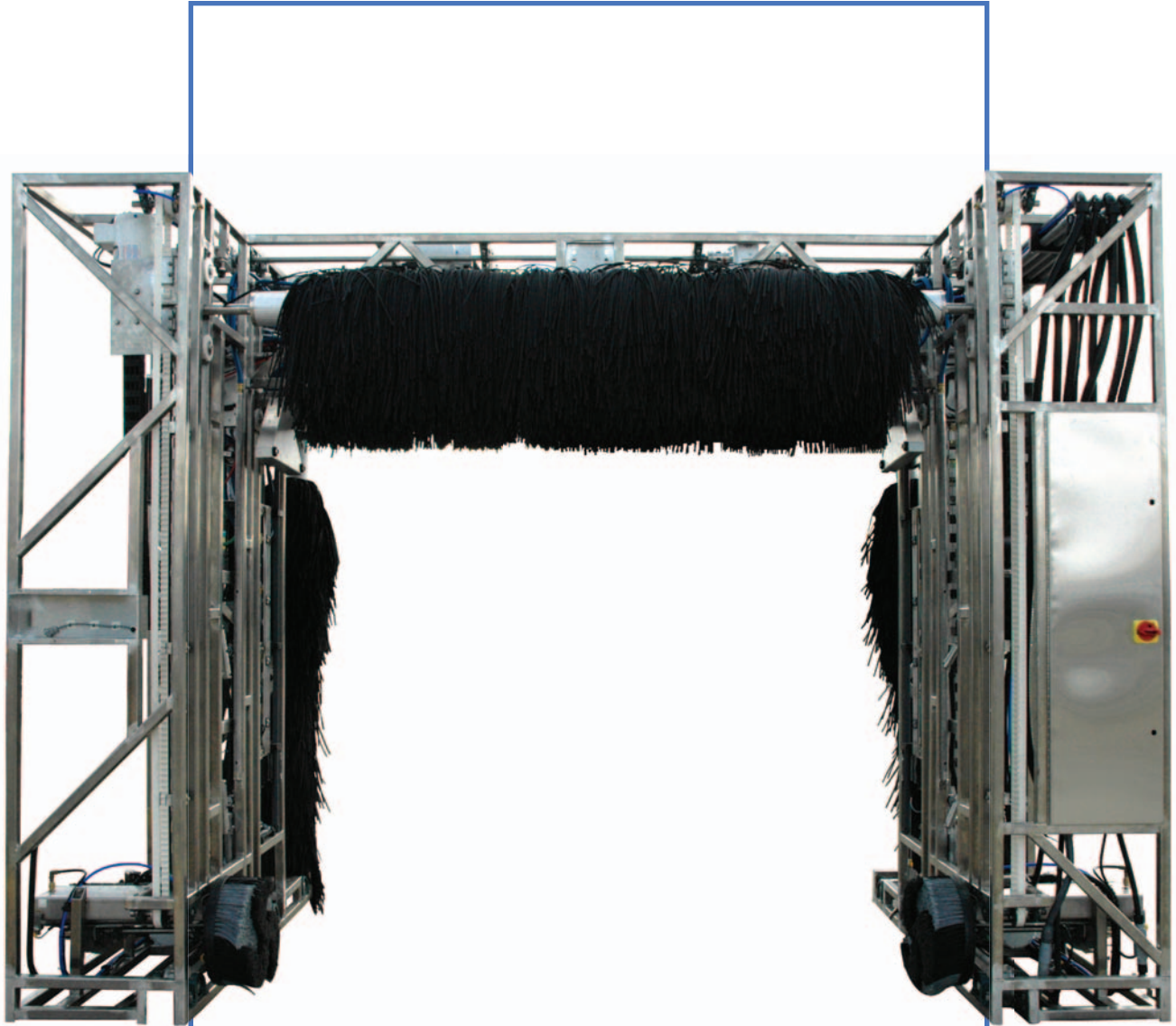

GANTRY ENTRANCE - WITHOUT SKINS



GANTRY EXIT - WITHOUT SKINS

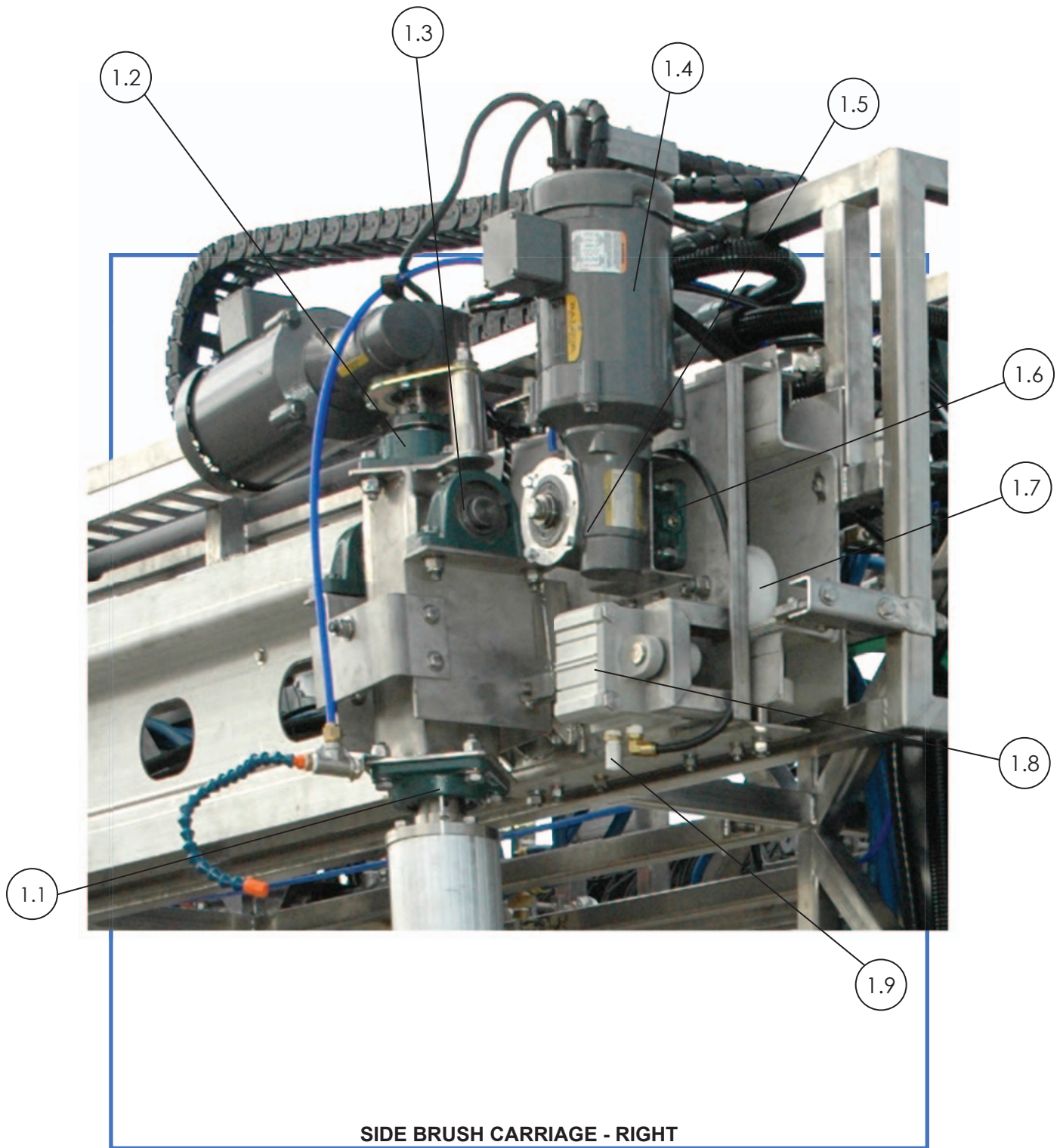

GANTRY – SIDE BRUSH CARRIAGE – RIGHT SIDE

ID#	PART#	DESCRIPTION
1.1	07513	Bearing, Flange 1.5" 4 Bolt
1.2	07514	Bearing, Flange Roller 1.5"
1.3	06851	Pillow Block-Vps-120
1.4	55001	Gear Motor, 10:1 Washdown Hs
1.5	55001	Gear Motor, 10:1 Washdown Hs
1.6	07511	Bearing, Flange 1" 4 Bolt
1.7	MS-AC52	Belt Idler Pulley
1.8	07501	Air Cyl, 100Mm Bore X 25Mm Strncq2D10025Dxc6
1.9	07502	Muffler, Pneumatic

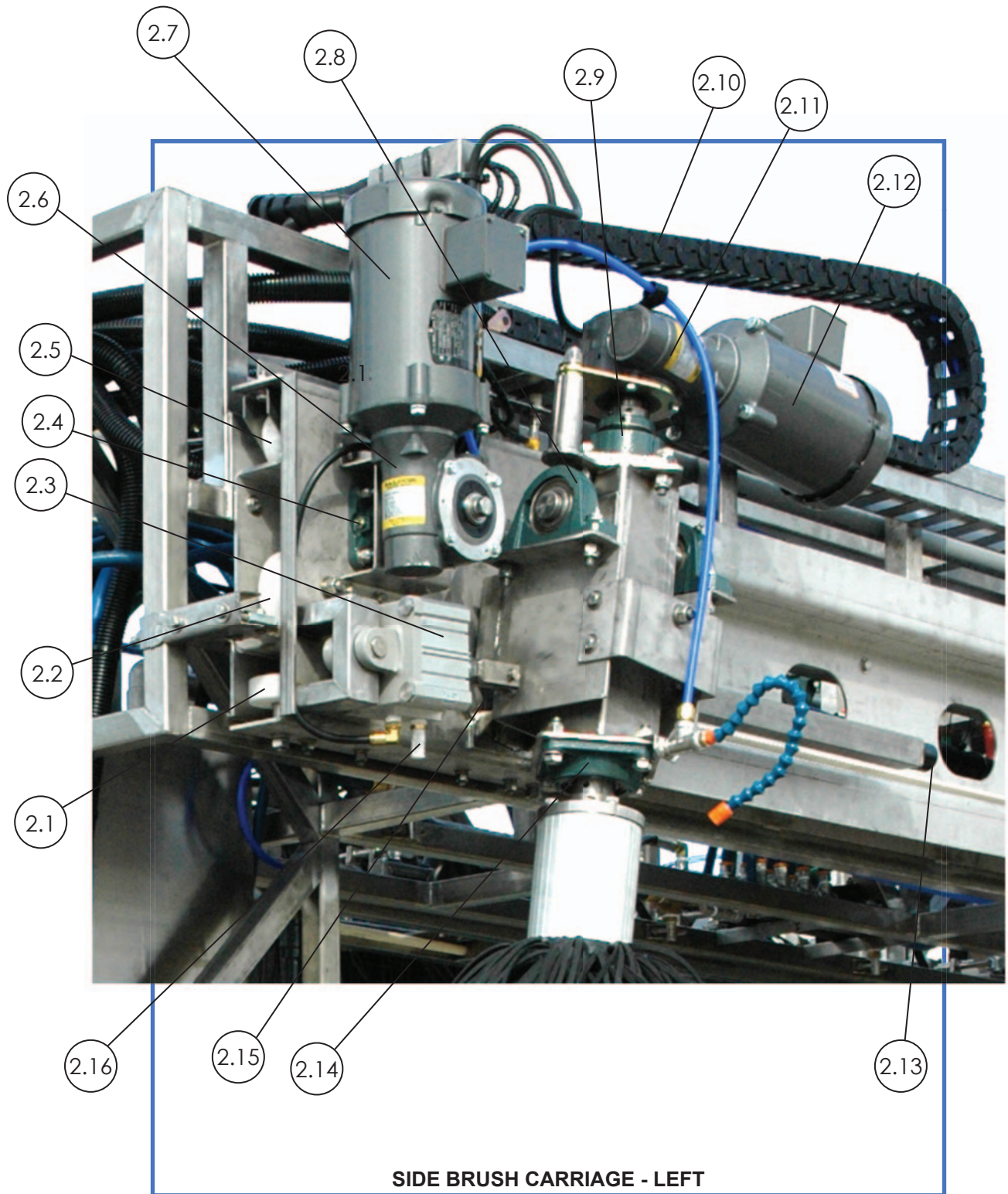

GANTRY – SIDE BRUSH – CARRIAGE – LEFT SIDE

ID#	PART#	DESCRIPTION
2.1	MS - AC51	Side Brush Carriage Rollers
2.2	MS - AC52	Belt Idler Pulley
2.3	07501	Air Cyl, 100Mm Bore X 25Mm
2.4	07511	Bearing, Flange 1" 4 Bolt
2.5	MS - AC51	Side Brush Carriage Rollers
2.6	55001	Gear Motor, 10:1 Washdown Hs
2.7	55001	Gear Motor, 10:1 Washdown Hs
2.8	06851	Pillow Block-Vps-120
2.9	07514	Bearing, Flange Roller 1.5"
2.10	07515	Cable Carrier, 2.25"X1.03"X8'
2.11	55001	Gear Motor, 10:1 Washdown Hs
2.12	55001	Gear Motor, 10:1 Washdown Hs
2.13	07528	Rubber Stopper
2.14	07513	Bearing, Flange 1.5" 4 Bolt
2.15	07528	Rubber Stopper
2.16	07502	Muffler, Pneumatic

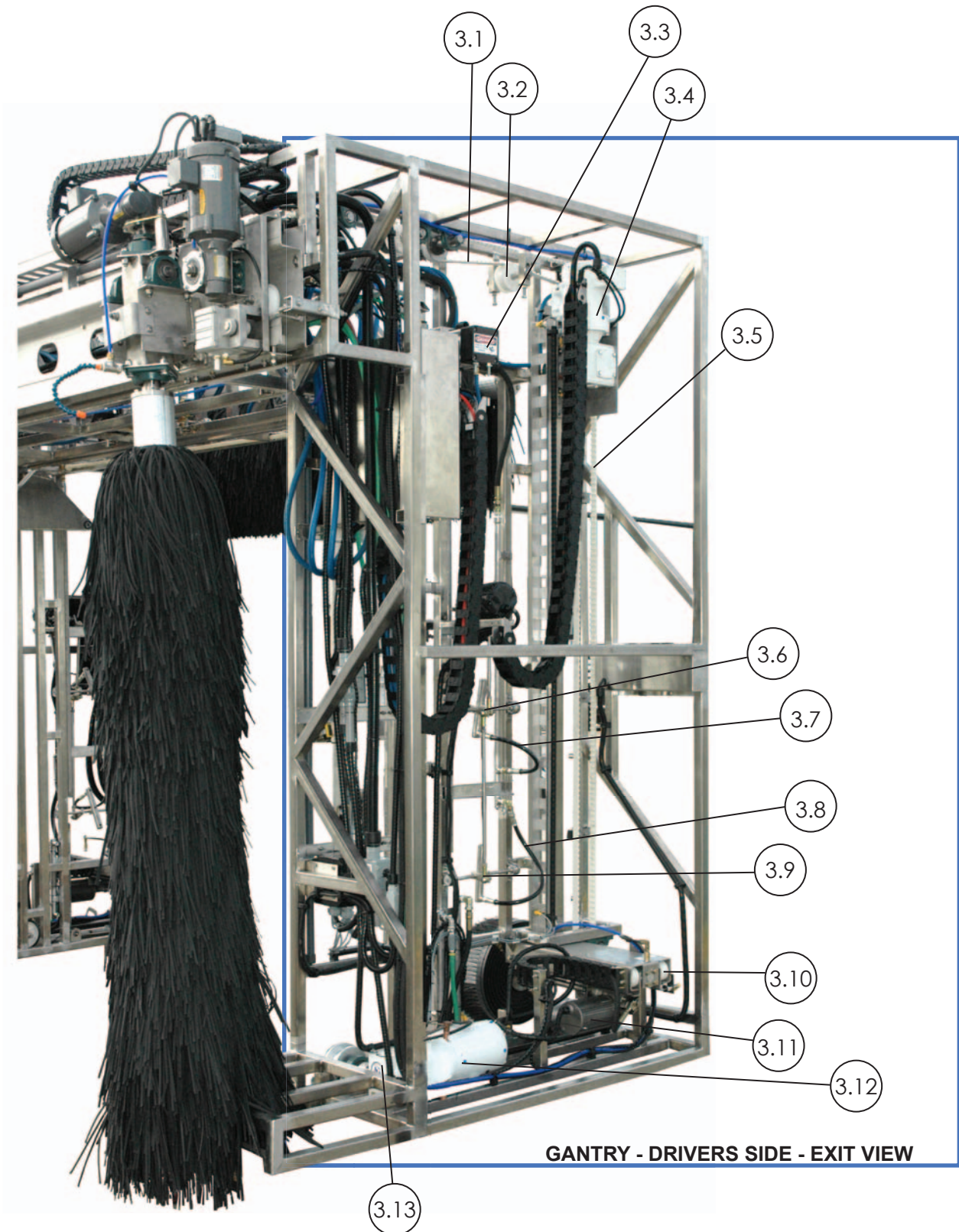

GANTRY - DRIVERS SIDE - EXIT VIEW

GANTRY – DRIVERS SIDE

ID#	PART#	DESCRIPTION
3.1	18013	Belt, Timing Ss Endless
3.2	MS-AC52	Belt Idler Pulley
3.3	06857	Rotary Actuator
3.4	55230-2	.5Hp, 3/60, Inv Dty, Washdown
3.5	18012	Belt, Timing Kevlar 50,000Mm
3.6	06838	Rod End-7/16"
3.7	22-00006	Hose, 3/8" Plastic X 19", 3/8
3.8	22-00007	Hose, 3/8" Plastic X 24"
3.9	06838	Rod End-7/16"
3.10	MS-AC54	Wheel Brush Side Rollers
3.11	55000	Gear Motor, 1/3Hp 30:1 1" Hs
3.12	55230-2	.5Hp, 3/60, Inv Dty, Washdown
3.13	55225-1	Gear Box Lf-918, 30:1 Washdown

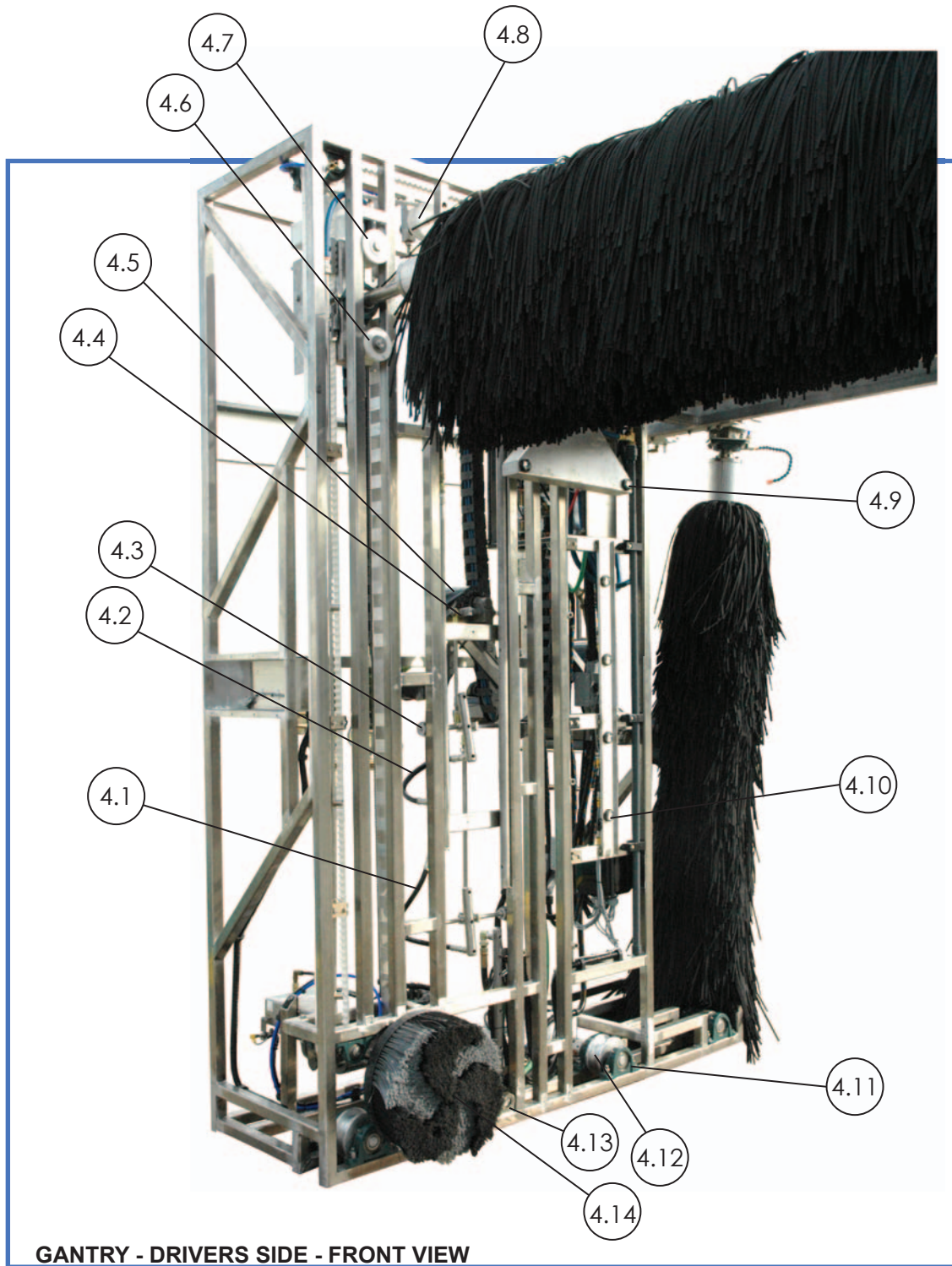

GANTRY – DRIVERS SIDE – FRONT VIEW

ID#	PART#	DESCRIPTION
4.1	22-00007	Hose, 3/8" Plastic X 24"
4.2	22-00006	Hose, 3/8" Plastic X 19"
4.3	06647	Pillow Block Bearing - 1/2"
4.4	06838	Rod End-7/16"
4.5	55236-1	.13 Oscillating Motor W/Gearbx
4.6	MS-AC56	Guide Roller Halves
4.7	MS-AC56	Guide Roller Halves
4.8	MS-AC52	Belt Idler Pulley
4.9	06712	Emitter, 8-Channel
4.10	06712	Emitter, 8-Channel
4.11	06851	Pillow Block-Vps-120
4.12	06500-W	Wheel, Drive
4.13	06712	Emitter, 8-Channel
4.14	07519	Wheel Brush, Silver/Black

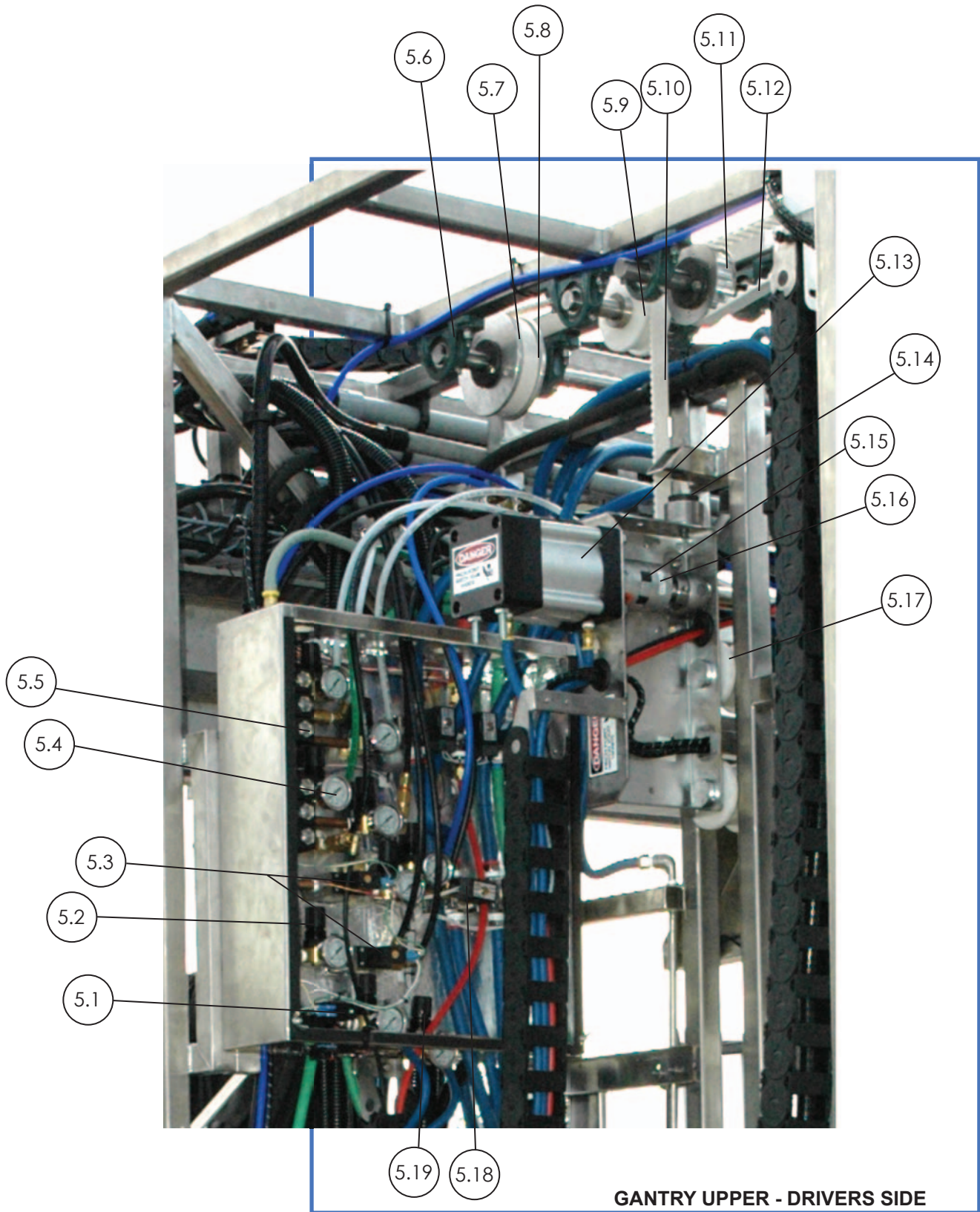

GANTRY UPPER – DRIVERS SIDE

ID#	PART#	DESCRIPTION
5.1	64075-1	Solenoid, Air Auto Dbl Act
5.2	58055	Regulator, Watts 1/4"
5.3	64000	Solenoid, Air 24Vac Coil
5.4	47027	Gauge-Wika 0-100Psi-Automatic
5.5	64021	43211N206-21 3Stage 1/4
5.6	06850	Pillow Blocks-Vps-116
5.7	06605	Pulley, Boom, Alum
5.8	06852	Belt-25At10/50,000-Mk92
5.9	MS-AC53	Belt Idler Pully
5.10	06852	Belt-25At10/50,000-Mk92
5.11	18009	Pulley, Cog 25Mm X 94Mm
5.12	18013	Belt, Timing Ss Endless
5.13	06857	Rotary Actuator
5.14	20053	Boom Stopper-Black Rubber
5.15	06803	Spider 1X406 Black
5.16	06800	Love Joy 1" Coupling
5.17	MS-AC56	Guide Roller Halves
5.18	06520	Solenoid Valve, 1/2", 24Vac
5.19	58056	Regulator, 3/8 Hi-Flow Mini

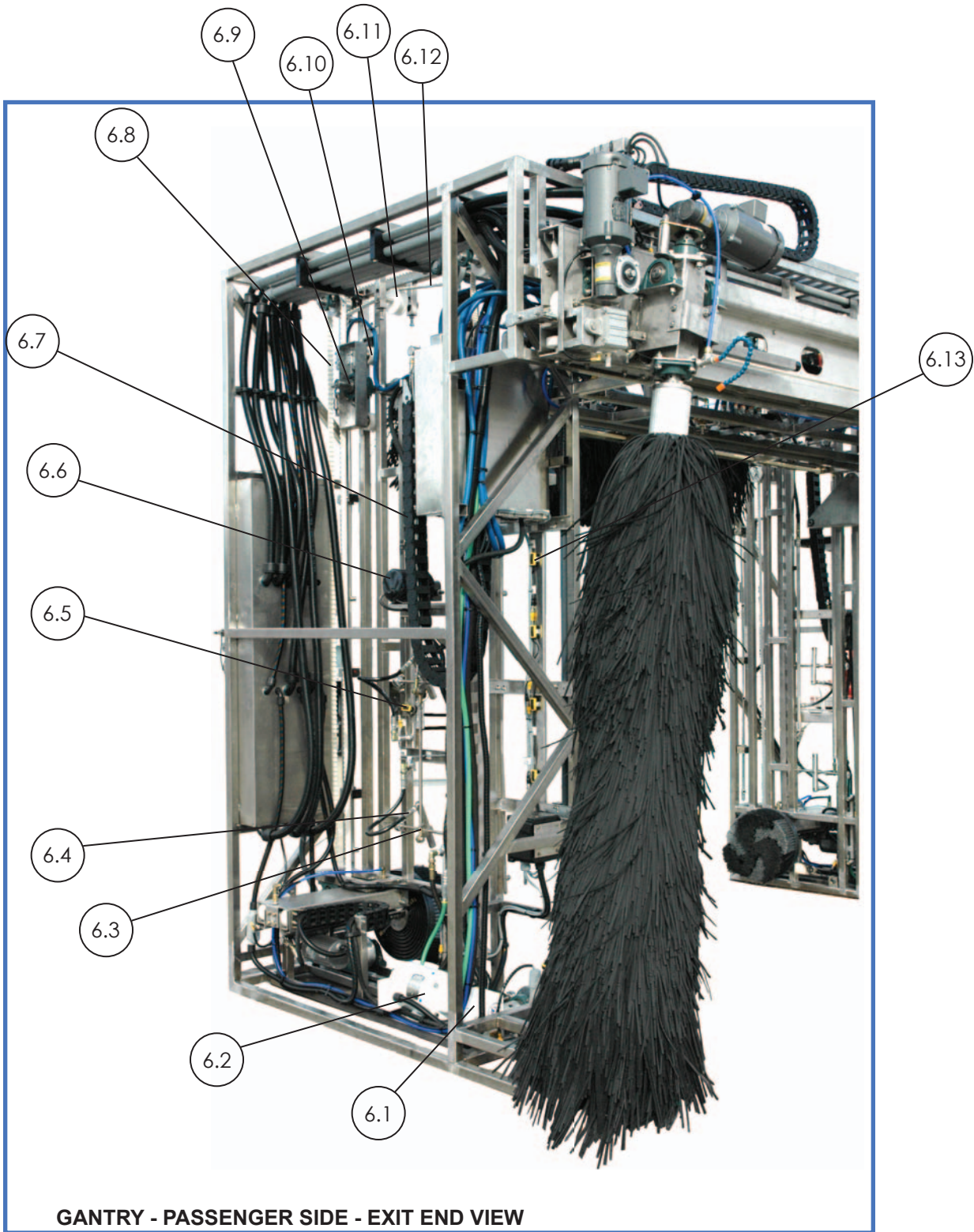

GANTRY - PASSENGER SIDE - EXIT END VIEW

GANTRY – PASSENGER SIDE – EXIT END VIEW

ID#	PART#	DESCRIPTION
6.1	55225-1	Gear Box Lf-918, 30:1 Washdown
6.2	55230-2	.5Hp, 3/60, Inv Dty, Washdown
6.3	06838	Rod End-7/16"
6.4	22-00007	Hose, 3/8" Plastic X 24"
6.5	06711	Reciever, 8-Channel
6.6	55236-1	.13 Oscillating Motor W/Gearbx
6.7	06767	Nylatrac, 2" X 6'
6.8	18012	Belt, Timing Kevlar 50,000Mm
6.9	07512	Bearing, Flange 1.5" 2 Bolt
6.10	MS-AC55	Top Brush Rollers
6.11	MS-AC52	Belt Idler Pulley
6.12	18013	Belt, Timing Ss Endless
6.13	06711	Reciever, 8-Channel

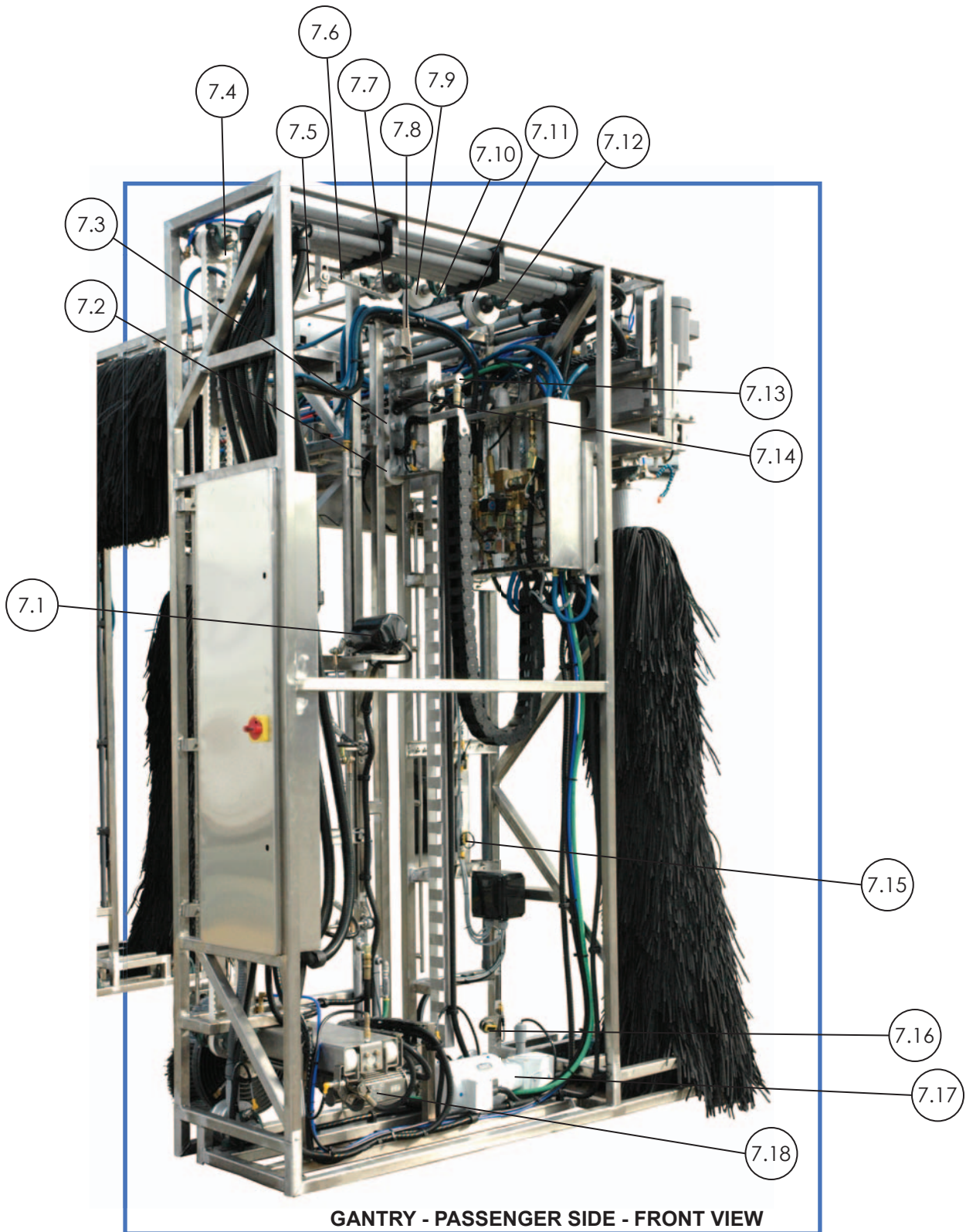

GANTRY – PASSENGER SIDE – FRONT VIEW

ID#	PART#	DESCRIPTION
7.1	55236-1	.13 Oscillating Motor W/Gearbx
7.2	MS-AC56	Roller Guide Halves
7.3	MS-AC56	Roller Guide Halves
7.4	18010	Pulley, Cog 50Mm X 94Mm
7.5	MS-AC52	Belt Idler Pulley
7.6	18013	Belt, Timing Ss Endless
7.7	18009	Pulley, Cog 25Mm X 94Mm
7.8	06852	Belt-25At10/50,000-Mk92
7.9	MS-AC53	Belt Idler Pulley
7.10	06850	Pillow Blocks-Vps-116
7.11	06605	Pulley, Boom, Alum Am002
7.12	06850	Pillow Blocks-Vps-116
7.13	74005	Swivel-1/2" X 90 Deg
7.14	06645-1	1-1/8" Poly-Hi Bearing
7.15	06711	Reciever, 8-Channel
7.16	06711	Reciever, 8-Channel
7.17	55225-1	Gear Box Lf-918, 30:1 Washdown
7.18	55000	Gear Motor, 1/3Hp 30:1 1" Hs

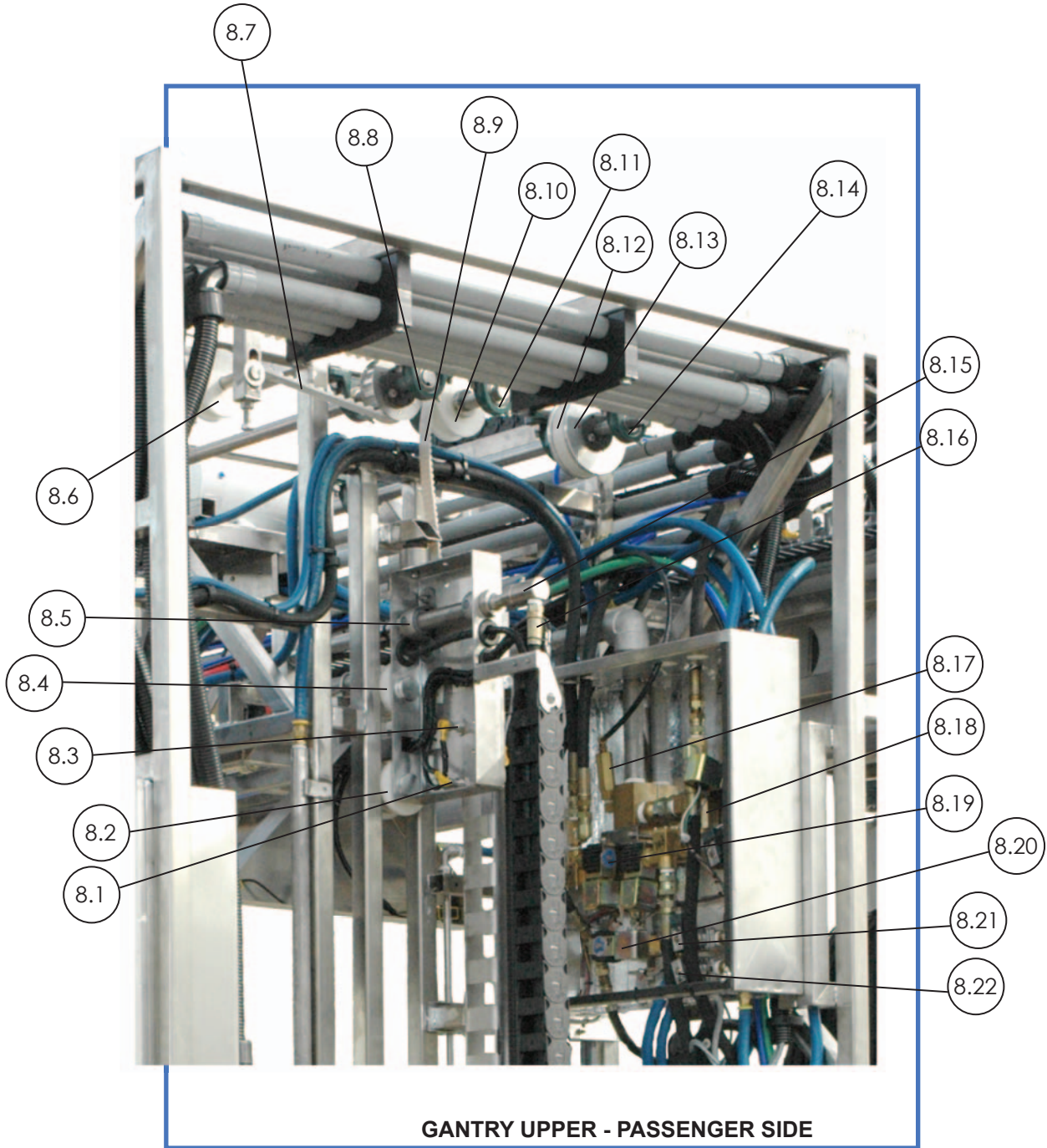

GANTRY UPPER – PASSENGER SIDE

ID#	PART#	DESCRIPTION
8.1	06626	Truck Prox Dc 18Mm
8.2	MS-AC56	Guide Roller Halves
8.3	06626	Truck Prox Dc 18Mm
8.4	MS-AC56	Guide Roller Halves
8.5	06645-1	1-1/8" Poly-Hi Bearing
8.6	MS-AC52	Belt Idler Pulley
8.7	18013	Belt, Timing Ss Endless
8.8	06850	Pillow Blocks-Vps-116
8.9	06852	Belt-25At10/50,000-Mk92
8.10	MS-AC53	Belt Idler Pulley
8.11	06850	Pillow Blocks-Vps-116
8.12	06852	Belt-25At10/50,000-Mk92
8.13	06605	Pulley, Boom, Alum Am002
8.14	06850	Pillow Blocks-Vps-116
8.15	74005	Swivel-1/2" X 90 Deg
8.16	52820	Hose, 1/2" W/B X 87", 1/2M-1/2M
8.17	34000	Check Valve, Brass Super-1/4"
8.18	31040	Dema Valve-458P 24V 1"
8.19	31030	Dema Valve-454P 24V 1/2"
8.20	31030	Dema Valve-454P 24V 1/2"
8.21	06520	Solenoid Valve, 1/2", 24Vac
8.22	06520	Solenoid Valve, 1/2", 24Vac

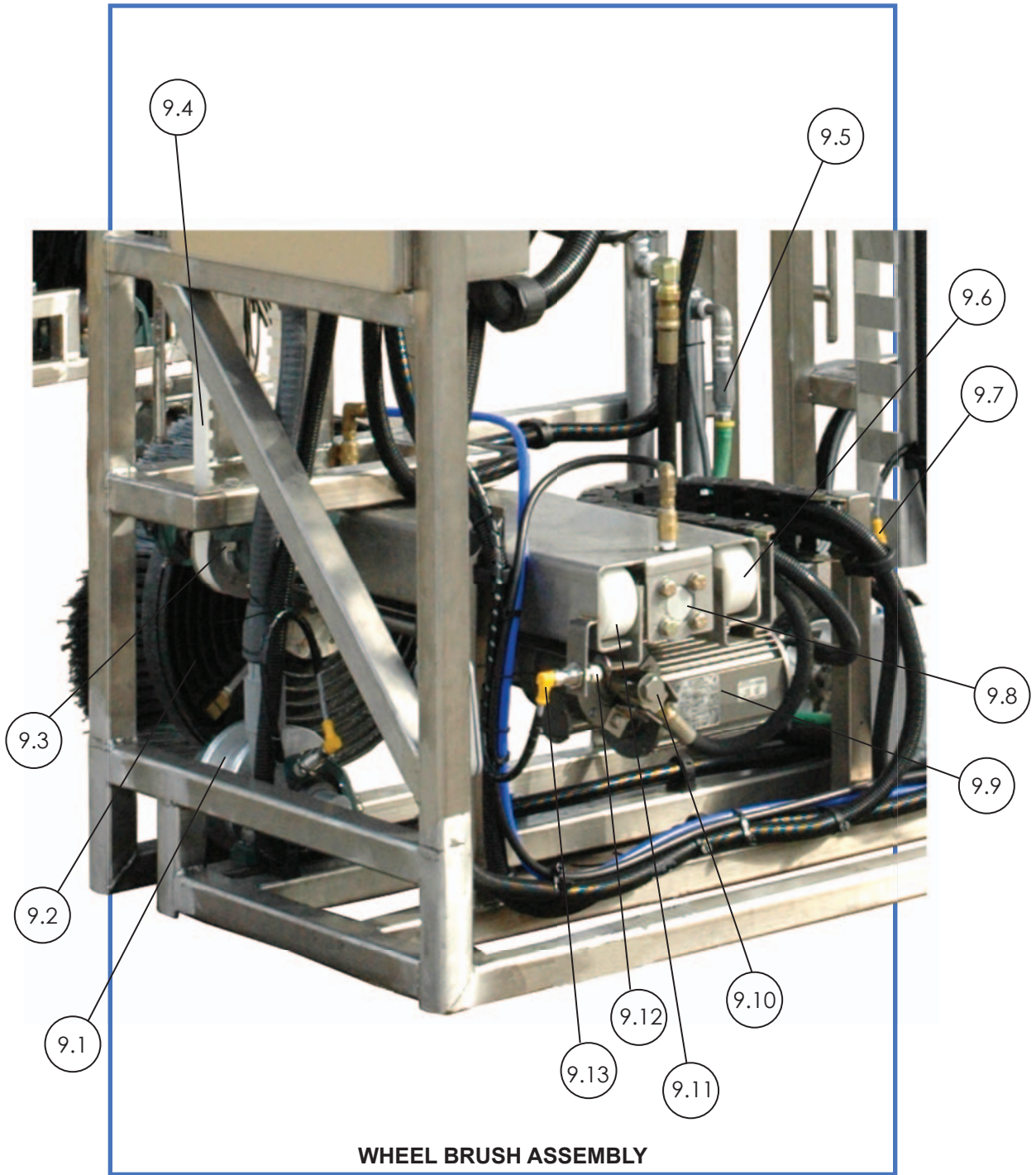

GANTRY – WHEEL BRUSH ASSEMBLY

ID#	PART#	DESCRIPTION
9.1	06500-W	Wheel, Drive
9.2	07519	Wheel Brush, Silver/Black
9.3	18009	Pulley, Cog 25Mm X 94Mm
9.4	18012	Belt, Timing Kevlar 50,000Mm
9.5	34025	Check Valve-Poly 1/4"
9.6	MS-AC54	Slide Rollers
9.7	06650-4	Cable Prox Rt Angle 4Mtr 90Deg
9.8	07504	Air Cyl, 2.5" Bore X 18"
9.9	55000	Gear Motor, 1/3Hp 30:1 1" Hs
9.10	74000	Swivel, 3/8" Hp M X F
9.11	MS-AC54	Slide Rollers
9.12	06626	Turck Prox Dc 18Mm
9.13	06650-12	Cable, Prox 15 Meter 90 Deg

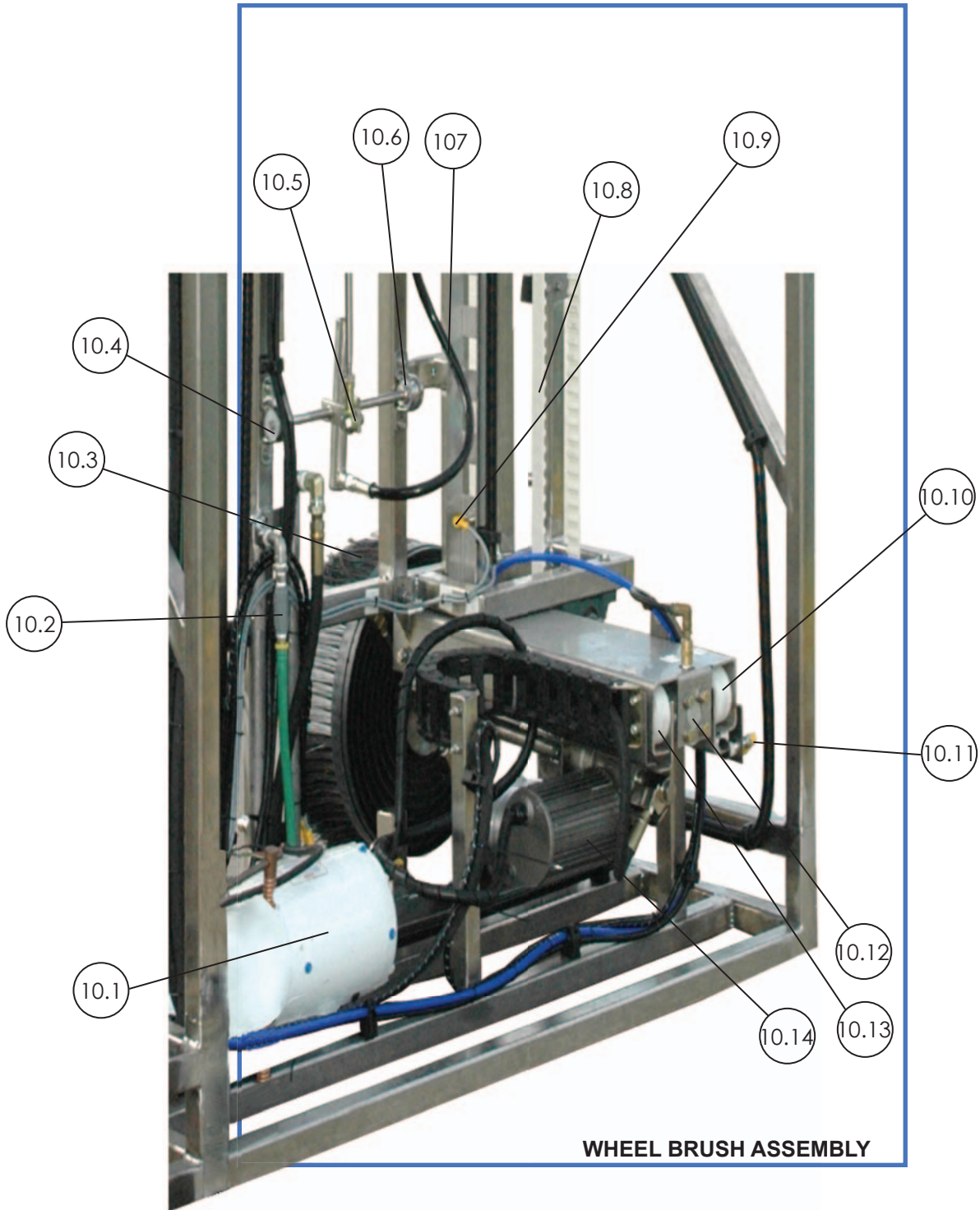

GANTRY – WHEEL BRUSH ASSEMBLY

ID#	PART#	DESCRIPTION
10.1	55230-2	.5Hp, 3/60, Inv Dty, Washdown
10.2	34025	Check Valve-Poly 1/4"
10.3	07519	Wheel Brush, Black/Silver
10.4	06647	Pillow Block Bearing - 1/2"
10.5	06838	Rod End-7/16"
10.6	06647	Pillow Block Bearing - 1/2"
10.7	22-00007	Hose, 3/8" Plastic X 24"
10.8	18012	Belt, Timing Kevlar 50,000Mm
10.9	06650-12	Cable, Prox 15 Meter 90 Deg
10.10	MS-AC54	Side Rollers
10.11	06650-4	Cable, Prox Rt. Angle 4Mtr 90Deg
10.12	07504	Air Cyl, 2.5" Bore X 18"
10.13	MS-AC54	Side Rollers
10.14	55000	Gear Motor, 1/3Hp 30:1 1" Hs

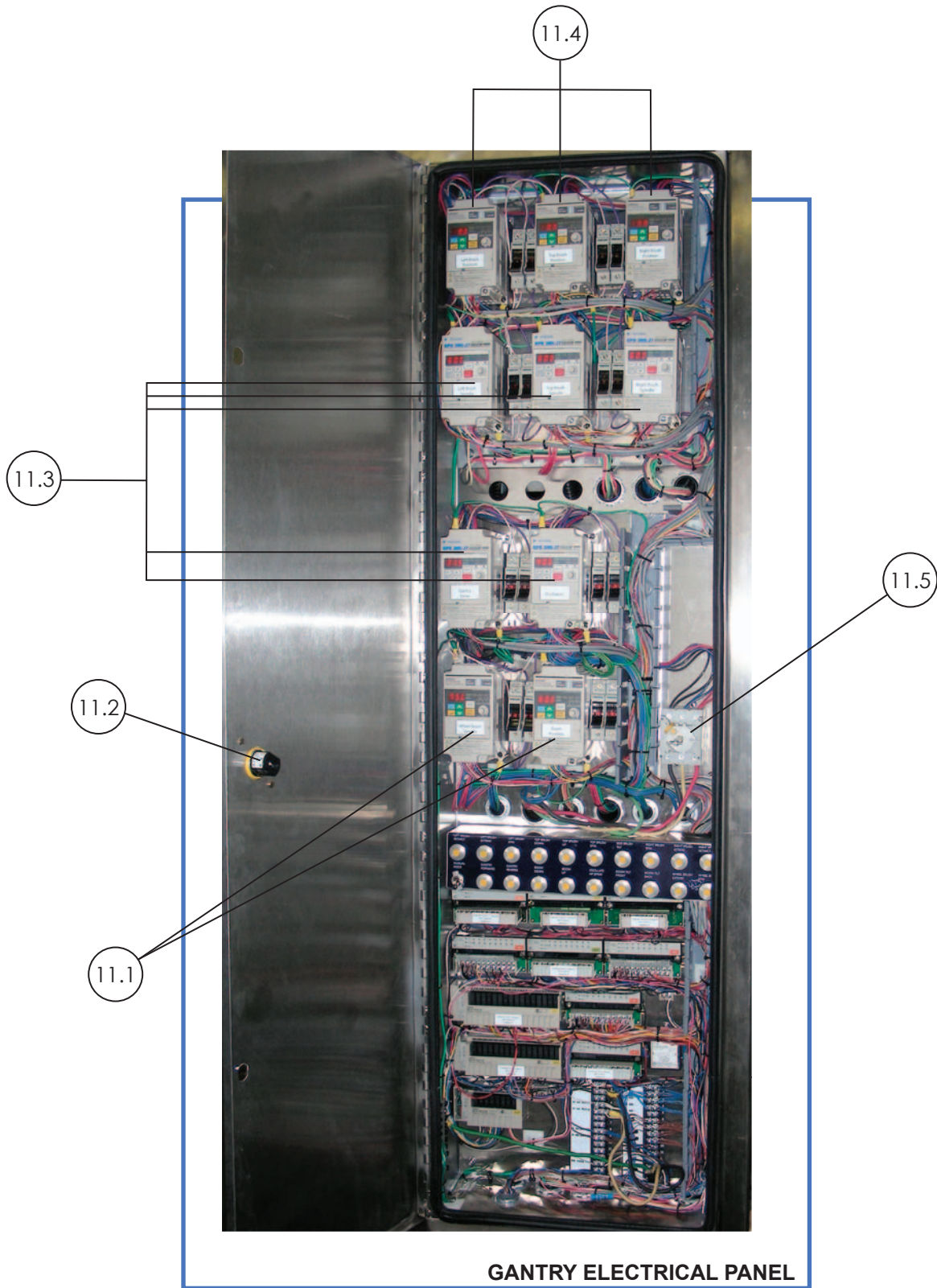

GANTRY – ELECTRICAL PANEL

ID#	PART#	DESCRIPTION
11.1	06971	Drive, 3/4Hp/230V/3Ph/50-60Hz
11.2	06997	Switch Handle Assy-Yellow/Red
11.3	06973	Drive, 1Hp/230V/5A/3Ph/50-60Hz
11.4	06971	Drive, 3/4Hp/230V/3Ph/50-60Hz
11.5	06995	63 Amp Disconnect Base Mount

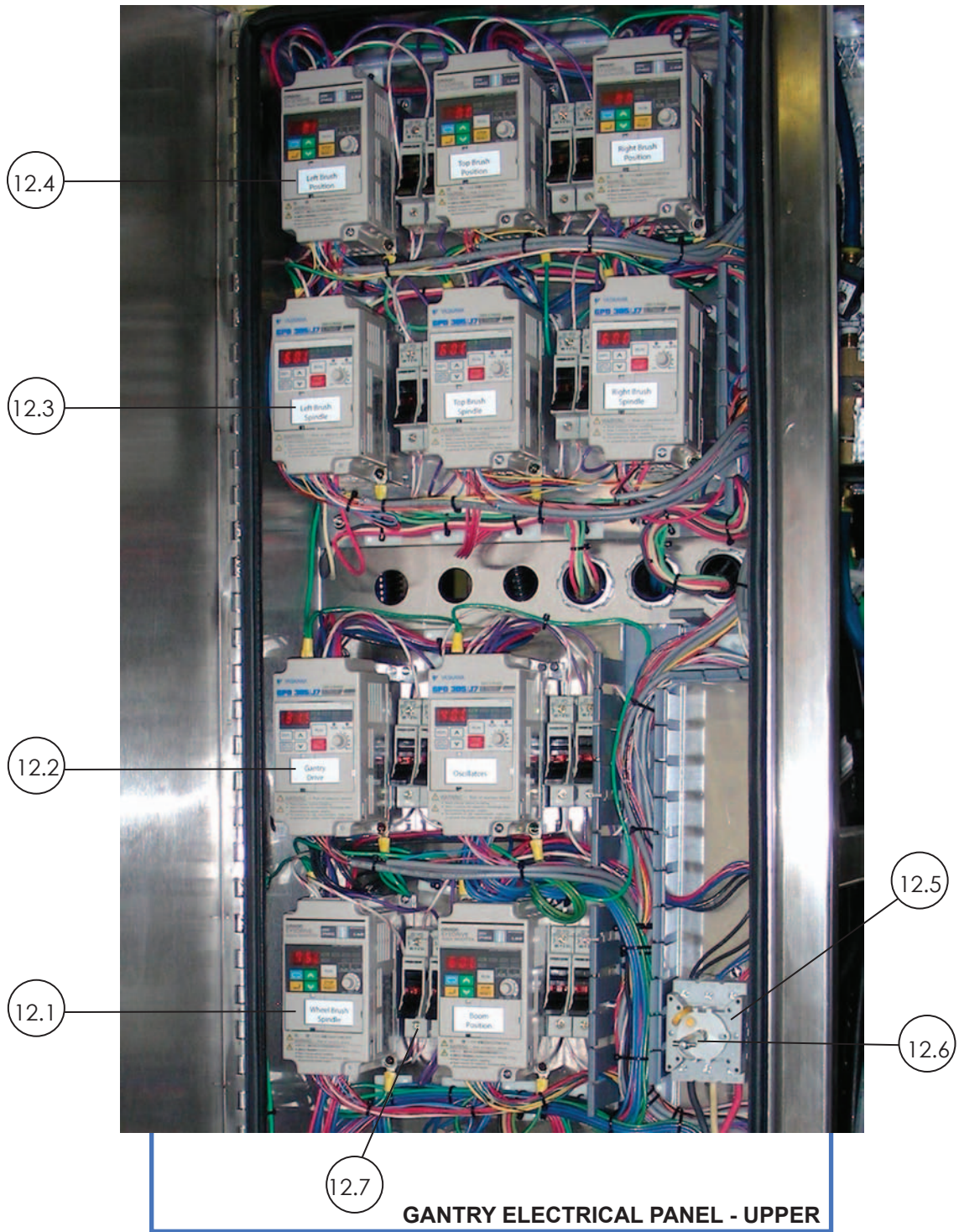

GANTRY ELECTRICAL PANEL - UPPER

ID#	PART#	DESCRIPTION
12.1	06971	Drive, 3/4Hp/230V/3Ph/50-60Hz
12.2	06973	Drive, 1Hp/230V/5A/3Ph/50-60Hz
12.3	06973	Drive, 1Hp/230V/5A/3Ph/50-60Hz
12.4	06971	Drive, 3/4Hp/230V/3Ph/50-60Hz
12.5	06995	63 Amp Disconnect Base Mount
12.6	06919	Bracket, Shaft Extension
12.7	40112-30 40032-6	Terminal Block, DI10/17.5Sf Fuse, Midget, 600V

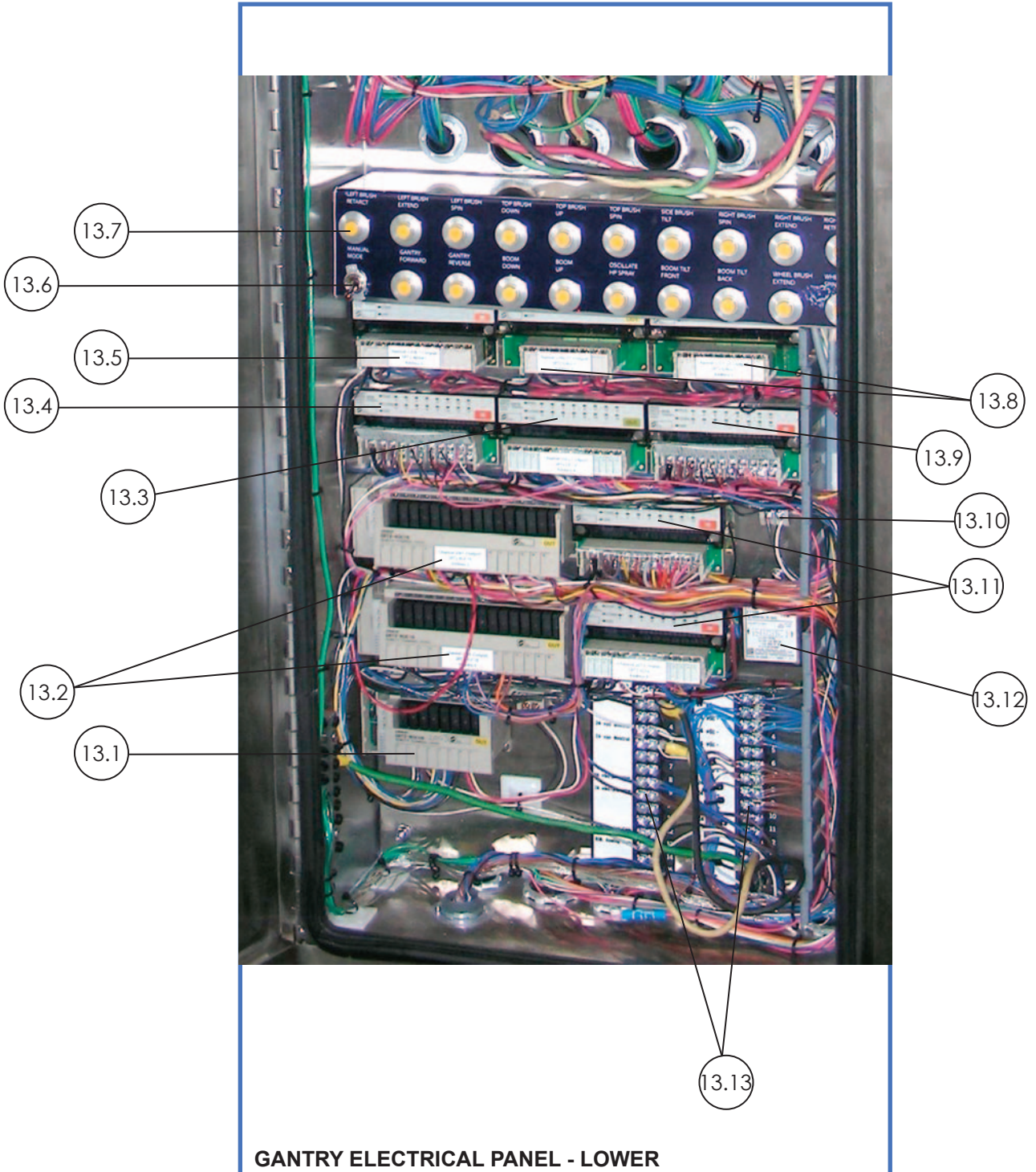

GANTRY ELECTRICAL PANEL - LOWER

GANTRY ELECTRICAL PANEL - LOWER

ID#	PART#	DESCRIPTION
13.1	06935	Relay Output Card-Srt1 Roc08
13.2	06940	Relay Output Card-Ww Srt2Roc16
13.3	07526	Transistor Output Card
13.4	06920	Input Card-Ww Srt2-Id16
13.5	07524	Analog Input Card
13.6	40069	Switch, Spst (On-Off) 15A/120
13.7	72026	Pushbutton, Yellow
13.8	07525	Analog Output Card
13.9	06920	Input Card-Ww Srt2-Id16
13.10	06950	Resistor, Termination-Ww Drs1-Tdrs1-T
13.11	06920	Input Card-Ww Srt2-Id16
13.12	06785	Filter-3Vk3
13.13	40010-2	Terminal Strip, 15 Pt

sparkleSOFT

TOP BRUSH WITH 25 UNICA SECTIONS

Unica K121 - 18 ways 50%

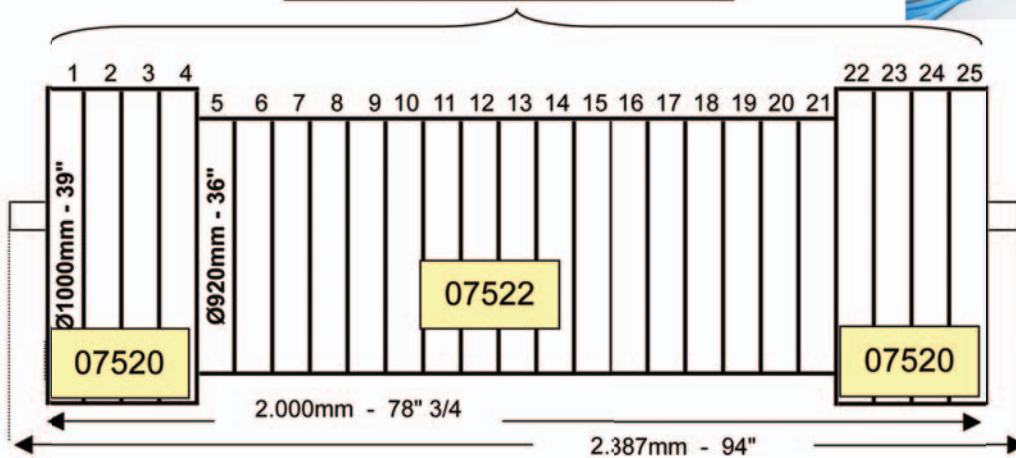

SIDE BRUSH WITH 22 UNICA SECTIONS

*JCC
Part Numbers

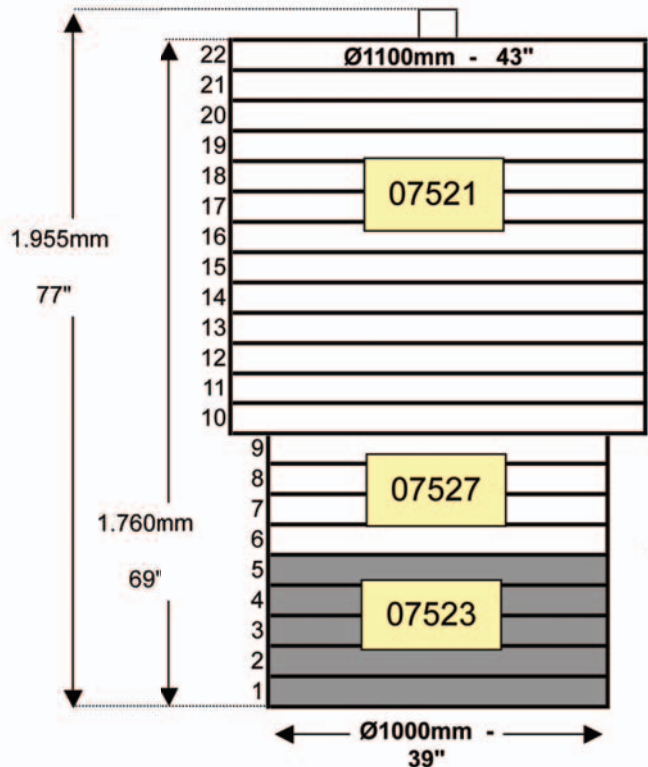

Unica K121
18 ways
50%

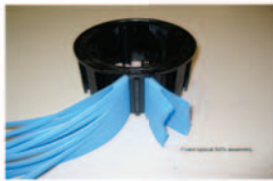

Unica K121
12 ways
100%

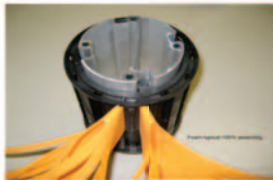

MIX
Unica K121
18 ways
Textile+Foam



pumpstand





FUSIONX PUMPSTAND WITH ECC



FUSIONX PUMPSTAND

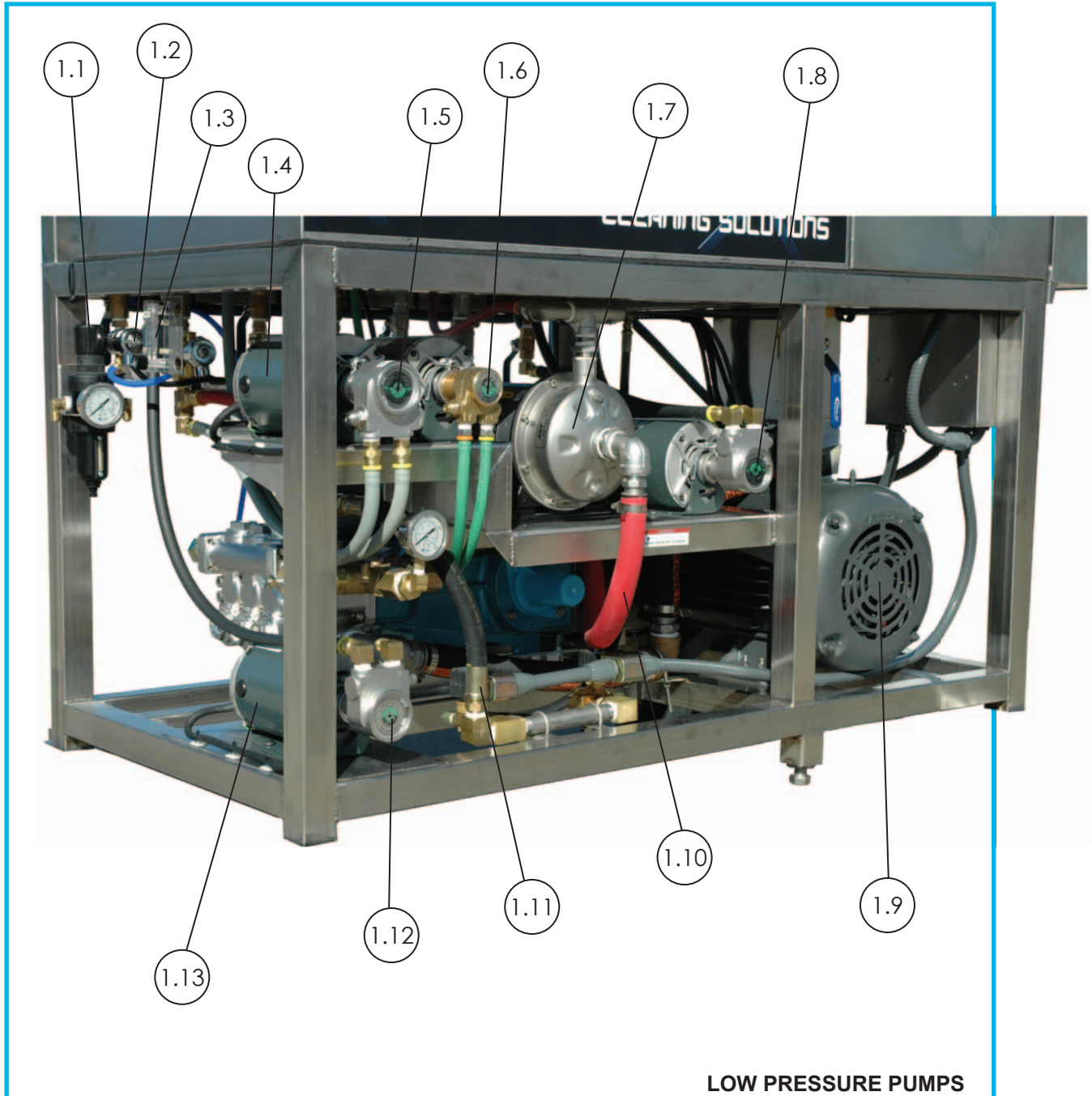

PUMP STAND – LOW PRESSURE PUMPS

ID#	PART#	DESCRIPTION
1.1	58090-1	Regulator-1/2" Parker
1.2	64071	3Bd7 Sol Valve 0-150 1/4" Ss
1.3	47075	Flow Meter, 4-40 Gpm
1.4	55016	Motor, 1/2 Hp, 1Ph
1.5	57007	Pump, 240Gph, 1/2Hp, S.S.
1.6	57002	Pump, 100Gph, 1/3Hp, Brass
1.7	32-3k133mt3	Pump, 2Hp/3Ph
1.8	57007	Pump, 240Gph, 1/2Hp, S.S.
1.9	55267	Motor 25Hp 1760 3Ph
1.10	52022	Hose-1" Push-Lok-Red Air/Water
1.11	52186	3/4" Wire Braid Hose (Undercarriage inlet)
1.12	57007	Pump, 240Gph, 1/2Hp, S.S.
1.13	55016	Motor, 1/2 Hp, 1 Ph

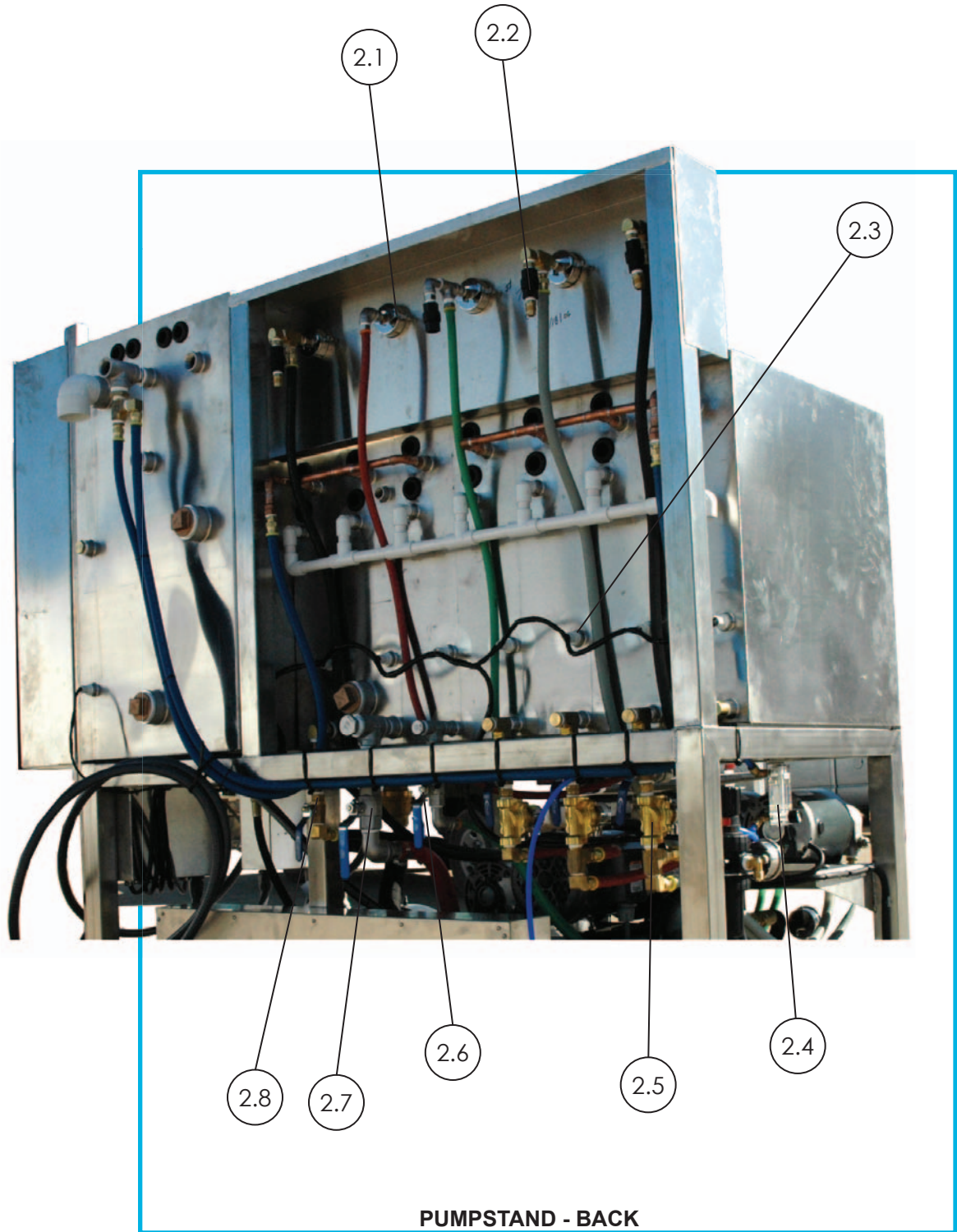

PUMPSTAND - BACK

ID#	PART#	DESCRIPTION
2.1	47010	Gauge and Bracket-Pressure 0-300 Panel
2.2	34020	Check Valve, Poly 3/8"
2.3	72050	Switch-Level (Side Mount)
2.4	47075	Flow Meter, 4-40 Gpm
2.5	64070	Solenoid-1/2Npt N.C. 24V
2.6	22450	Valve, Ball-1/2", 1000Psi
2.7	22101	Valve, Ball, 1", Full Port
2.8	22-V500P-8	Ball Valve-1/2" Brass

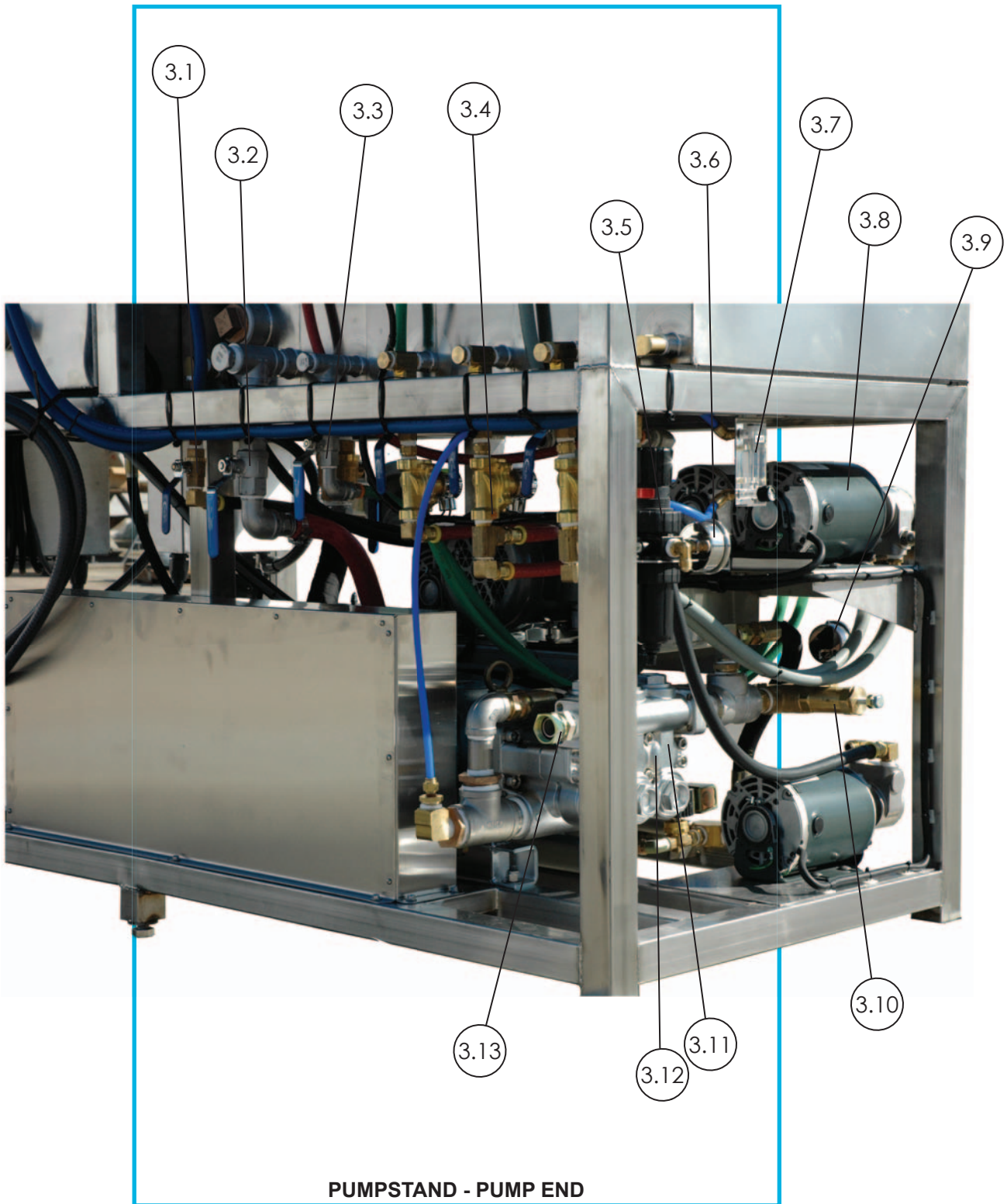

PUMPSTAND – PUMP END

ID#	PART#	DESCRIPTION
3.1	22-V500P-8	Ball Valve-1/2" Brass
3.2	22101	Valve, Ball, 1", Full Port
3.3	22450	Valve, Ball-1/2", 1000Psi
3.4	64070	Solenoid-1/2Npt N.C. 24V
3.5	58090-1	Regulator-1/2" Parker
3.6	47010	Gauge-Pressure 0-300 Panel Mt
3.7	47075	Flow Meter, 4-40 Gpm
3.8	55016	Motor, 1/2 Hp, 1 Ph
3.9	47011	Gauge-Pressure 0-300 Stem Mt
3.10	06760	Unloader-1"
3.11	32-3535	Cat 3535-35Pfr Pump 36Gpm
3.12	32-3535	Cat 3535-35Pfr Pump 36Gpm
3.13	22-0107-16-16	1"M To Female Pipe Swivel

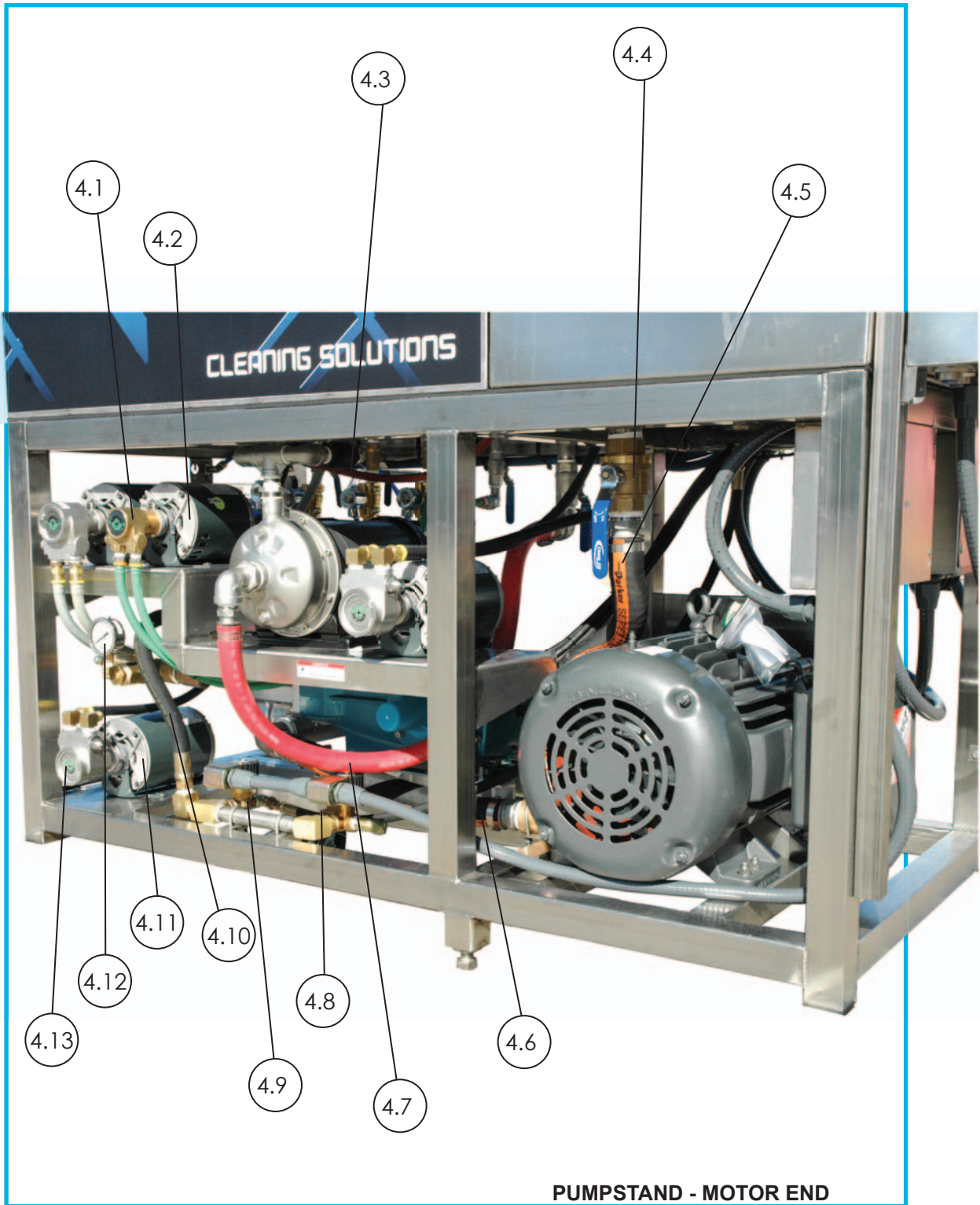

PUMPSTAND - MOTOR END

PUMPSTAND – MOTOR END

ID#	PART#	DESCRIPTION
4.1	57002	Pump, 100Gph, 1/3Hp, Brass
4.2	55013	Motor, 1/3 Hp, 1Ph
4.3	22-421-8	1/2" Wire Braid Hose Sae (52017)
4.4	22-V500P-24	Ball Valve-1-1/2"
4.5	52021	Hose, Suction, 1 1/2"
4.6	52021	Hose, Suction, 1 1/2"
4.7	22-801-16-R	Push Lock Hose-1"Red Air/Water
4.8	31030	Dema Valve-454P 24V 1/2"
4.9	31020	Dema Valve-453P 24V 3/8"
4.10	52816	Male Pipe Each End J 412 X 19"
4.11	55016	Motor, 1/2 Hp, 1 Ph
4.12	47020	Gauge-Pressure 0-2000Psi L/Mnt
4.13	57007	Pump, 240Gph, 1/2Hp, S.S.



PUMPSTAND – CONTROL PANEL

ID#	PART#	DESCRIPTION
5.1	72026	Pushbutton, Yellow
5.2	06681	Op. Interface, 128 X 64 - Red Lion
5.3	06997	Switch Handle Assy-Yellow/Red
5.4	24385	Cam Lock 2 Pos W/1Key,Nut,Wshr

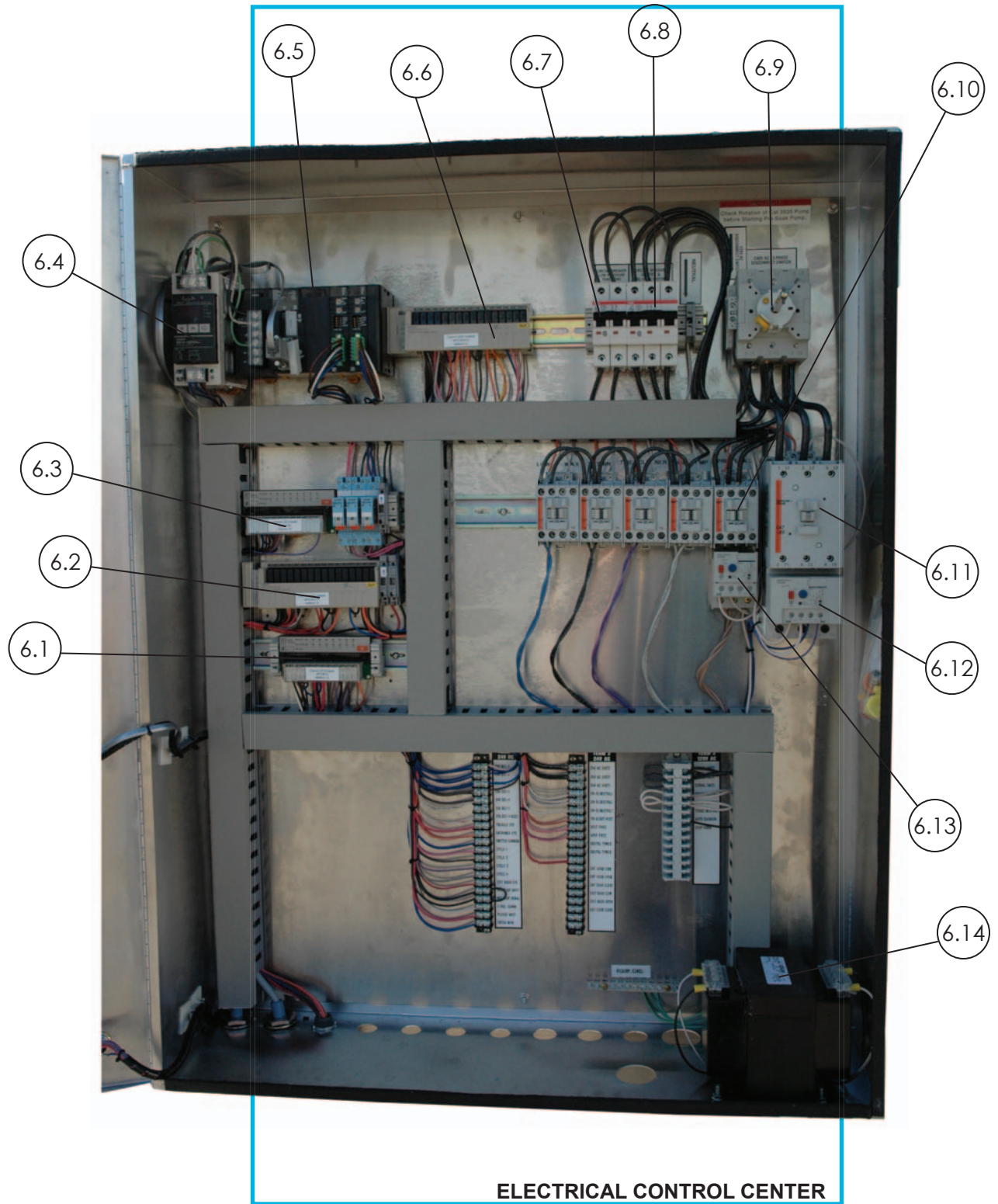

PUMPSTAND – ELECTRICAL CONTROL CENTER

ID#	PART#	DESCRIPTION
6.1	06920	Input Card-Ww Srt2-Id16
6.2	06940	Relay Output Card-Ww Srt2Roc16
6.3	06920	Input Card-Ww Srt2-Id16
6.4	06960	DC Power Supply-Omron
6.5	07503	Cpu (Fusion)
6.6	06940	Relay Output Card-Ww Srt2Roc16
6.7	40074	2P 16A Breaker UI489
6.8	40027	3P 20A Breaker UI489
6.9	06919-1	Shaft, Eec Operator
6.10	60056	Contactora, 16Amp 4Pole Ss
6.11	60065	Contactora, 85 Amp, 4 Pole 120V
6.12	60066-1	Overload, 18 - 90Amp
6.13	60062-1	Overload, 3.2 - 16Amp
6.14	40190-5	Transformer 500Va 120/240-24V

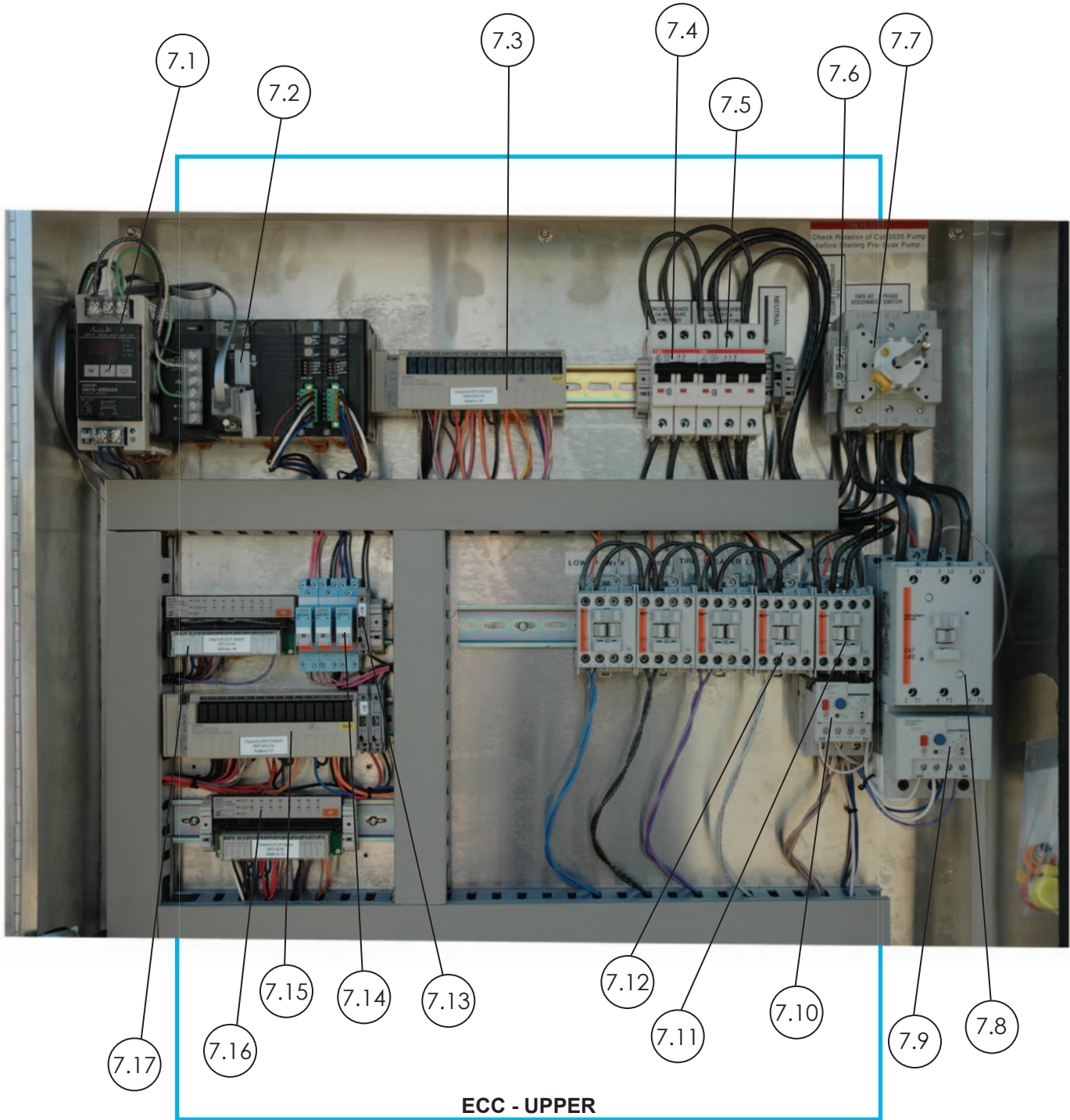

PUMPSTAND – ECC - UPPER

ID#	PART#	DESCRIPTION
7.1	06960	DC Power Supply-Omron
7.2	07503	Cpu (Fusion)
7.3	06940	Relay Output Card-Ww Srt2Roc16
7.4	40074	2P 16A Breaker UI489
7.5	40027	3P 20A Breaker UI489
7.6	06996	Aux Relay Contacts
7.7	06994	100 Amp Disconnect Base Mount
7.8	60065	Contactor, 85 Amp, 4 Pole 120V
7.9	60066-1	Overload, 18 - 90Amp
7.10	60062-1	Overload, 3.2 - 16Amp
7.11	60056	Contactor, 16Amp 4Pole Ss
7.12	60056	Contactor, 16Amp 4Pole Ss
7.13	40032-2	Fuse, Glass 10A 250V
7.14	06948	Relay, 24 Vadc-Ac/Dc Coil
7.15	06940	Relay Output Card-Ww Srt2Roc16
7.16	06920	Input Card-Ww Srt2-Id16
7.17	06920	Input Card-Ww Srt2-Id16

PUMPSTAND – ECC – I/O CARDS

ID#	PART#	DESCRIPTION
8.1	06920	Input Card-Ww Srt2-Id16
8.2	06940	Relay Output Card-Ww Srt2Roc16
8.3	06948	Relay, 24 Vadc-Ac/Dc Coil
8.4	40340-2 40032-2	Block, Terminal Fusehldr 24V 10 Amp Fuse
8.5	40340-1 40032-3	Block, Terminal Fusehldr 120V 3 Amp Fuse
8.6	06920	Input Card-Ww Srt2-Id16

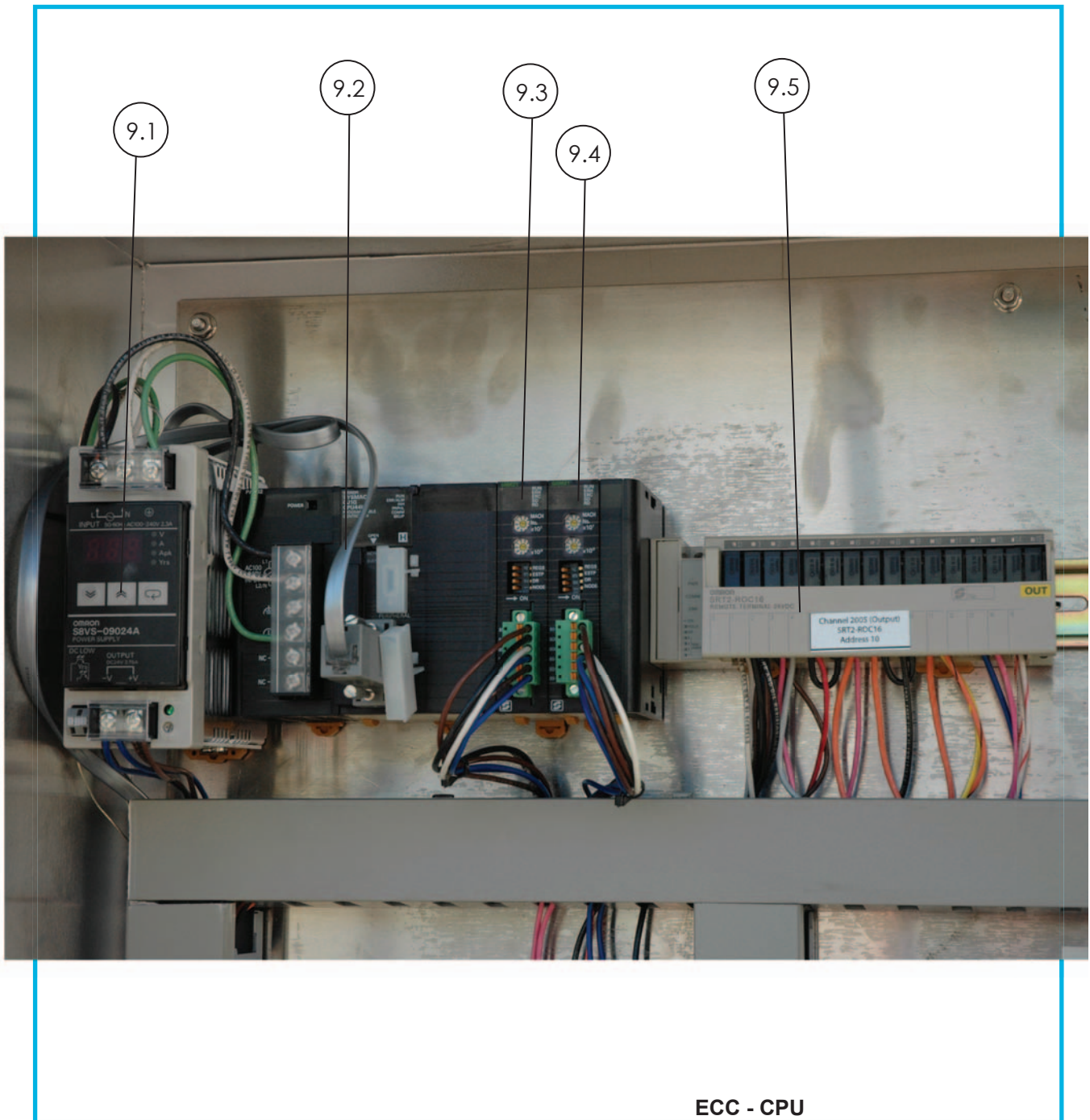

ECC - CPU

PUMP STAND – ECC – CPU

ID#	PART#	DESCRIPTION
9.1	06960	Power Supply-Omron
9.2	06508	Cable, Red Lion to Computer
9.3	06680-2	Cj1 - Compobus/S - Master
9.4	06680-2	Cj1 - Compobus/S - Master
9.5	06940	Relay Output Card-Ww Srt2Roc16



For more information on all world class car wash
equipment and parts manufactured by
Jim Coleman Company
please contact us at:

1.800.999.9878
5842 W. 34th Street
Houston, Texas 77092
www.jcolemanco.com

Parts Department Direct Line:
1.866.927.4229
Fax: 713.590.6652

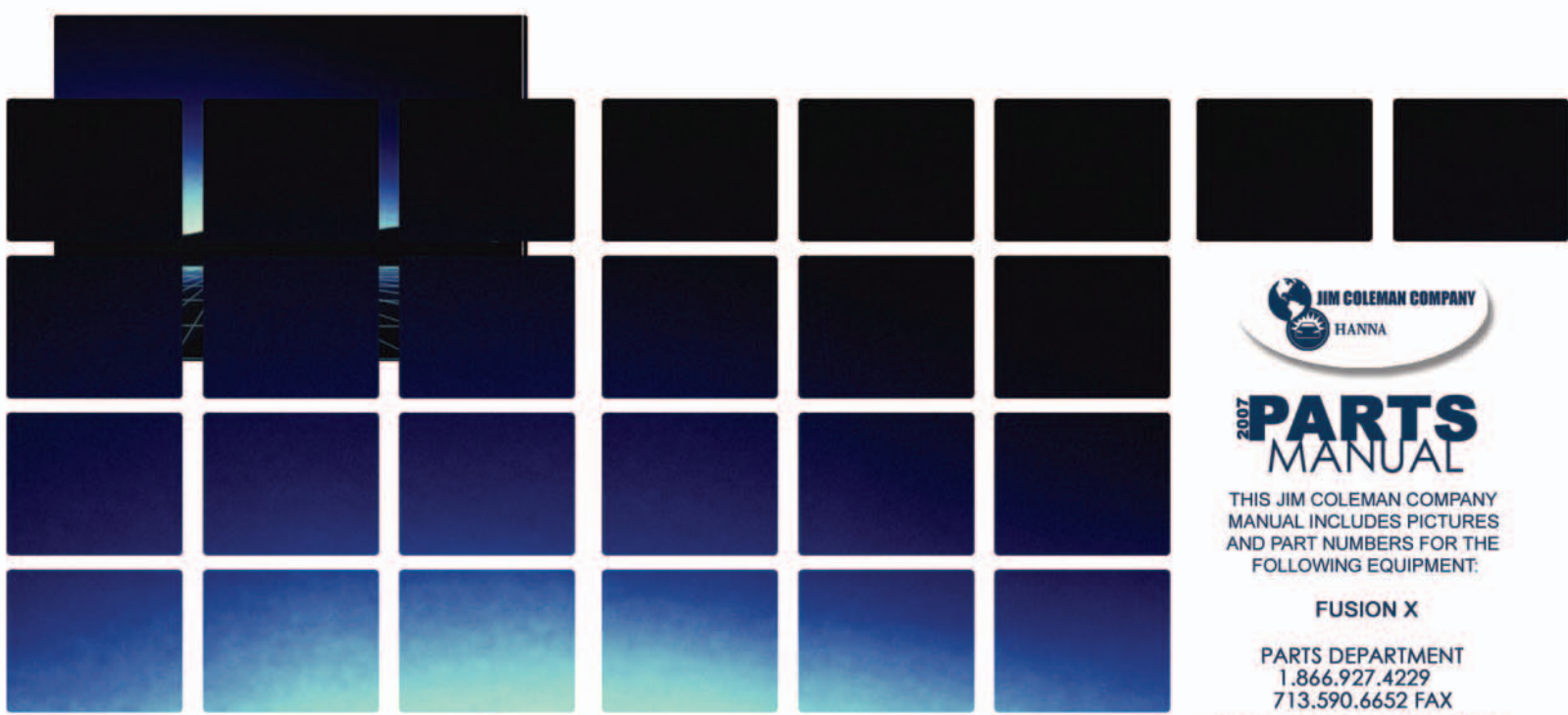

2007 PARTS MANUAL

THIS JIM COLEMAN COMPANY
MANUAL INCLUDES PICTURES
AND PART NUMBERS FOR THE
FOLLOWING EQUIPMENT:

FUSION X

PARTS DEPARTMENT
1.866.927.4229
713.590.6652 FAX

WWW.JCOLEMANCO.COM